

	



TRX 特锐祥
专 注 电 容 器 廿 年

	SMD- 1 SMD 1 . .		
	/N		/D
	/E		/P

 TRX 专注电容器廿年	SMD- 1 SMD 1 . .		
	/N		/D
	/E		/P

1. /P N

T G _1 102 K

		×

2. /P

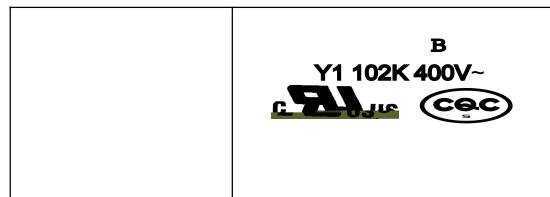

 TRX 专注电容器廿年	SMD- 1		
	SMD 1 . .		
	/N		/D
/E		/P	

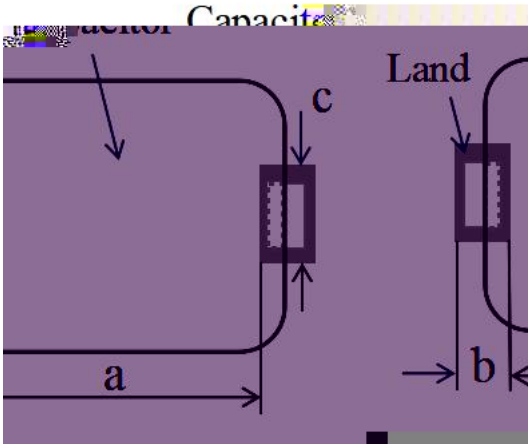

6. /S
/

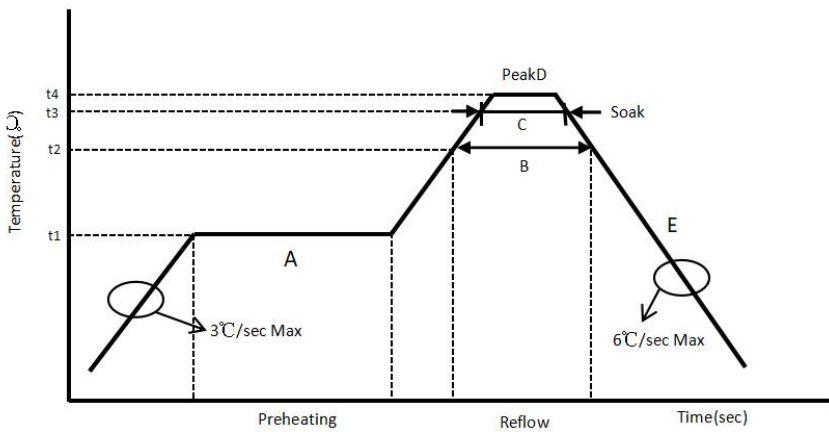

	SMD- 1 SMD 1 . .		
	/N		/D
	/E		/P

/

/

7. /P

 TRX 专注电容器廿年	SMD- 1		
	SMD 1 . .		
	/N		/D
/E		/P	

			± ±
			± ±
			± ±
			± ±
			± ±
			± ±
			± ±
			± ±
			± ±

8. /C

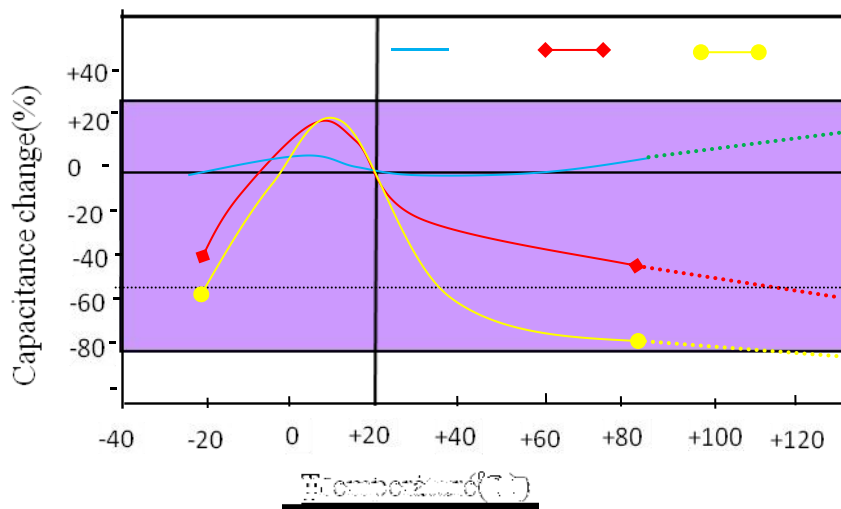



SMD- 1
SMD 1 . .

/N

/D

/E

/P

11. /P

/

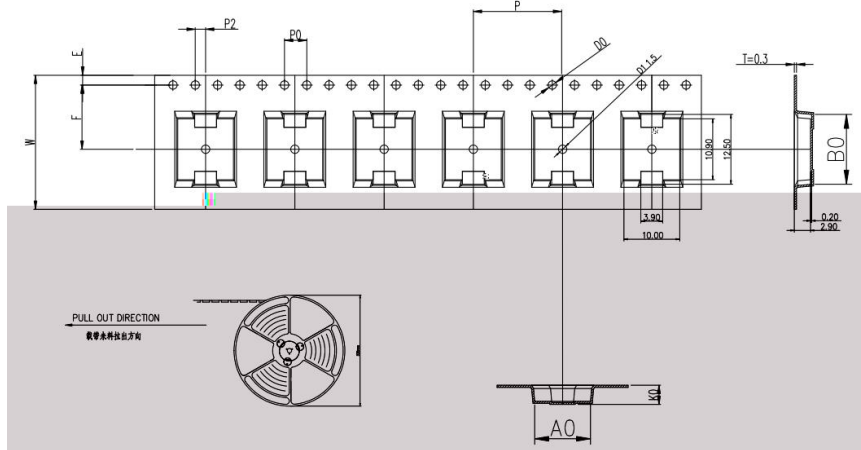

ITEM	W	A0	B0	K1	K0	P	F	E	D0	D1	P0	P2	T
DIM	24.0	$^{+0.30}_{-0.30}$	$^{+0.10}_{-0.10}$	$^{+0.10}_{-0.10}$	$^{+0.10}_{-0.10}$	$^{+0.10}_{-0.10}$	$^{+0.10}_{-0.10}$	$^{+0.10}_{-0.10}$	$^{+0.10}_{-0.00}$	$^{+0.10}_{-0.00}$	$^{+0.10}_{-0.10}$	$^{+0.10}_{-0.10}$	$^{+0.05}_{-0.05}$
ALTERNATE													

/

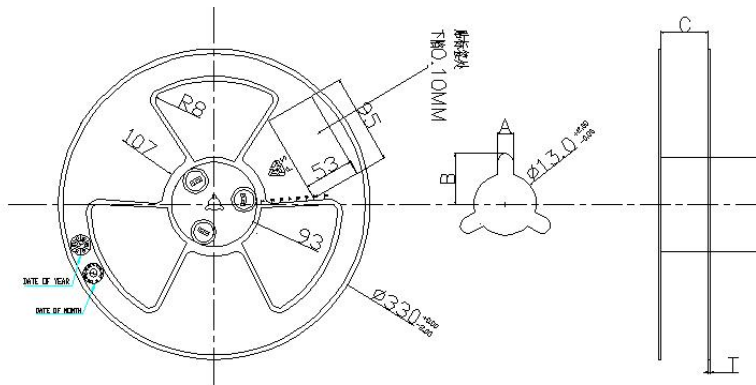

SPEC	A±0.3	B±0.5	C $^{+0.5}_{-0.0}$	D±0.5	T±0.2
24	2.3	10.75	24.4	Ø97	2.2

/

Item	Data	Remark
Cover tape adhesion	10 ~ 100g	Carrier tape and cover tape open angle 165 ~ 180° F=300± 5mm/minute

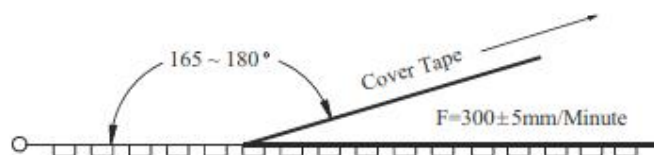

 TRX 专注电容器廿年	SMD- 1 SMD 1 . .		
	/N		/D
	/E		/P

/ -

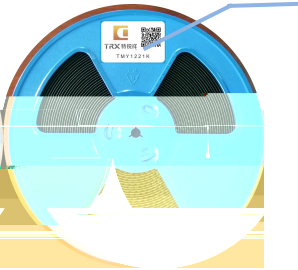



TRX 特锐祥
TGY1102K

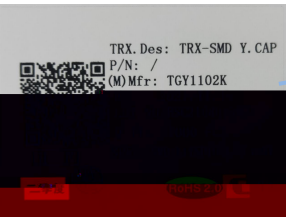



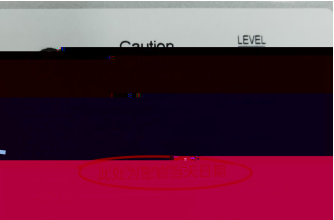

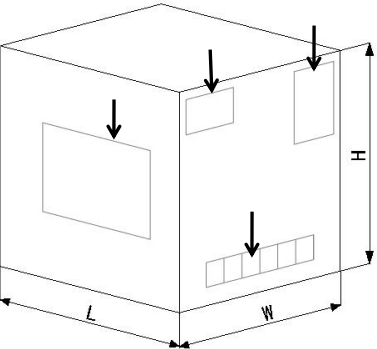

/O -







/
/
/

/P :









/
/

" "

R

