

# 深圳市弗瑞鑫电子有限公司

## 规格承认书

: /  
: \_\_\_\_\_ 单  
: \_\_\_\_\_ 单

prepare	
check	
/	
approve	



TRX电容一级代理商

深圳市弗瑞鑫电子有限公司

Add:深圳市宝安区西乡大道302号金源商务大厦B座3楼

Tel:0755-29563634

Fax:0755-27447020

---

2

2 . .

---

/

-3-082

/

2021-11-15

---

/

A1

/

P 3 18

---

 <b>TRX</b> 专注电容器廿年	2			
	2 . .			
	/	-3-082	/	2021-11-15
	/	A1	/	P 4 18

## /CON EN

1.	P	N	-----	5
2.	P		-----	5-6
3.	D		-----	6
4.	C		-----	7
5.	P		-----	7-8
6.			-----	8-9
7.	P		-----	9-14
8.	C		-----	14
9.	C		-----	15
10.			-----	15
11.	P	P	-----	16-17
12.	A		-----	18

	2 2 . .			
	/	-3-082	/	2021-11-15
	/	A1	/	P 5 18

1. /

$\overline{\text{①}}$   $\overline{\text{②}}$   $\overline{\text{③}}$   $\overline{\text{④}}$   $\overline{\text{⑤}}$   $\overline{\text{⑥}}$

N . C

E

①

L

 <b>TRX</b> 专注电容器廿年	2			
	2 . .			
	/	-3-082	/	2021-11-15
	/	A1	/	P 6 18

3. /



		2020	M	1	01	1	01	16	16
		2021	N	2	02	2	02	17	17
2010	A	2022	P	3	03	3	03	18	18
2011	B	2023		4	04	4	04	19	19
2012	C	2024		5	05	5	05	20	20
2013	D	2025		6	06	6	06	21	21
2014	E	2026		7	07	7	07	22	22
2015	F	2027	8	8	08	8	08	23	23
2016	H	2028		9	09	9	09	24	24
2017	J	2029		10	10	10	10	00	

4. /

C		C	C
L/C L	L/C A 60384-14	E315719	AC3008 ( . . . )
C C	GB/ 6346.14-2015	C C20001280609	AC3008 ( . . . )
ENEC	EN 60384-14:2013/A1:2016	ENEC-03177	AC3008 ( . . . )
KC	K60384-14	H 03034-21003A	AC2508 ( . . . )

5. /

5.1 /P D

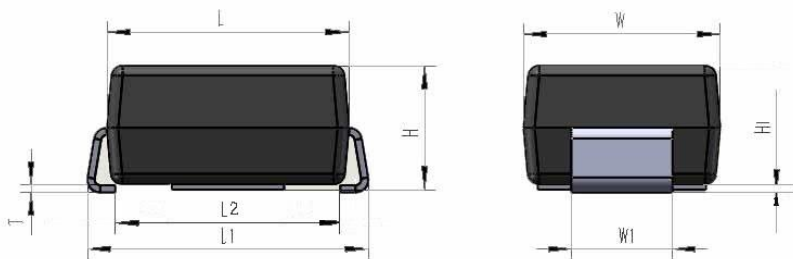

P		D		( )	
L	4.3 0.1			3.5 0.3	
L1	5.0 0.1	L2		4.0 0.1	
H	2.2 0.1	1		1.8 0.05	
H1	0.1 0.05			0.13 0.02	

5.2 /P

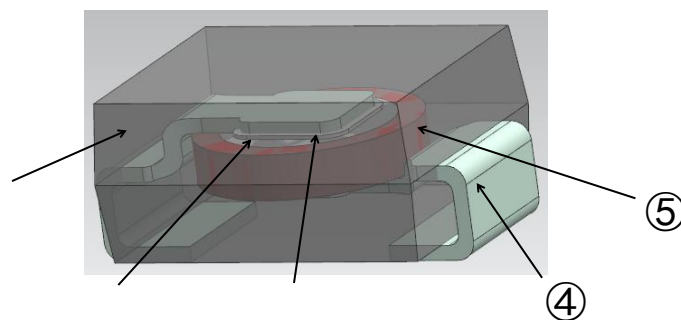

N .	P	M
①	C	E ( L98 -0) ( L98 -0)
②	E	/C
③		-P -A -P -A
④	L P	
⑤	D	C

2

2 . .

/

-3-082

/

2021-11-15

/

 <b>TRX</b> 专注电容器廿年	2			
	2 . .			
	/	-3-082	/	2021-11-15
	/	A1	/	P 9 18

6.2 /F

280 °  
280°C

30 °  
30

200 °  
200

P 200

180 °  
180

P 180

6.3 / I  
PCB/P B

PCB/P B,

400  
- 400

50  
50

5  
5

7. /

NO	I		
1	A	N L L	
2	D	5.1 5.1	



	2 2 . .			
	/	-3-082	/	2021-11-15
	/	A1	/	P 10 18

NO	I	
----	---	--

3 8 0 □ LV~~07~~

 <b>TRX</b> 专注电容器廿年	2 2 . .			
	/	-3-082	/	2021-11-15
	/	A1	/	P 11 18

NO	I		
8			150 180 C 90 30 P 150 180 C 90 30 . / : 230 C-260 C / : 60 15 . / :4 15--35 45--75% H 24 2 L 15-35 , 45-75% H 24 2 , .
		NO.3 P NO.3	
	C	L: 10% 5P: 10% 5 : 20% 8 : 20%	
	D.F.	L: 1.0% 5P: 2.5% 5 : 2.5% 8 : 2.5%	
	I .	NO.7 P NO.7	
9		G	(JI K 5902) (JI K 8101) (25%) ( ) I (JI K 8101) (JI K 5902) (25%) ). ( ) I 2 0.5 2 0.5 . : 245 10 C
10		N	: +125 3
		NO.3 P NO.3	: -40 3
	C	L: 10% 5P: 10% 5 : 20% 8 : 20%	: 5
	D.F.	L: 1.0% 5P: 2.5% 5 : 2.5% 8 : 2.5%	30 25 3 24 2
	I .	NO.7 P NO.7	C 24 2 25 3 .

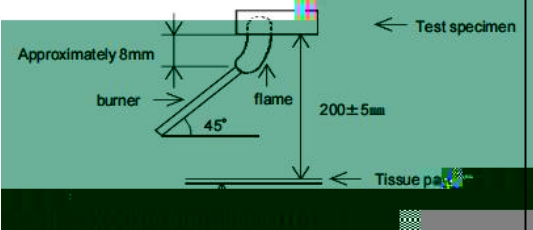

 <b>TRX</b> 专注电容器廿年	2		
	2 . .		
	/	-3-082	/
	/	A1	/
			2021-11-15
			P 13 18

NO	I		
14	I	N	
		I	P : 5.0K8
		24 3	I : 10
		I 24 3	I : 24
15	P	30	30
		30 .	. E
		30	: 30 .
		/L : 12 1	
		35	
		G : L 35 .	
		/I : 0.5 0.1	
		/O : 0.9 .	
		95%	
		G : B 95% .	
			

 <b>TRX</b> 专注电容器廿年	2			
	2 . .			
	/	-3-082	/	2021-11-15
	/	A1	/	P 14 18

NO	I		
16	C	N P NO.3 NO.7 N .3 N .7	:30 5% 70 5% :30 5% 70 5% / :23 5 5 0.5 5 0.5 / :8
17			:30 5% 70 5% :30 5% 70 5% / :23 5 5 0.5 10 5 0.5 10

8. /

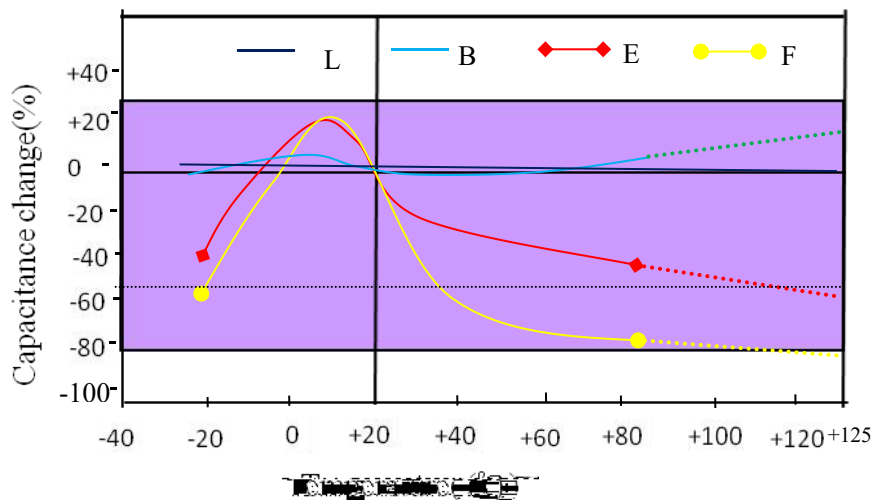

		2		
	/	-3-082	/	2021-11-15
	/	A1	/	P 15 18

9. /

H 2.0 2011/65/E

EACH N 190 7/2006



	( : )
/C	<100
/L	<1000
/M	<1000
/H	<1000
PBB /P	<1000
PBDE /P	<1000
+ + + /C +P +H +C +6( )	<100
/C	<900
/B	<900
+ /C +B	<1500
EACH 8 H C ( 8 HC) EACH	EACH

10. /

(1).

E ; , , , ,  
 . A , , , , ,

(2).

12

12

(3).

/ : 10 30  
 /H : 60%

168

(4).

6

60 168

I

6

HIC

(60 168 )

 <b>TRX</b> 专注电容器廿年	2			
	2 . .			
	/	-3-082	/	2021-11-15
	/	A1	/	P 16 18

11. /  
11.1 /D

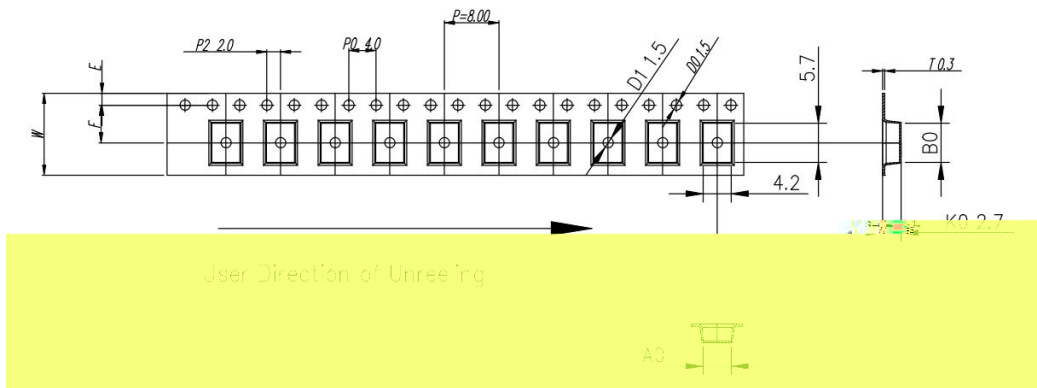

ITEM	W	A0	B0	K1	K0	P	F	E	D0	D1	P0	P2	T
DIM	12.0	$4.30^{+0.10}_{-0.30}$	$5.70^{+0.10}_{-0.10}$	--	$2.70^{+0.10}_{-0.10}$	8.00	$5.50^{+0.10}_{-0.10}$	1.75	$\phi 1.5^{+0.10}_{-0.10}$	$\phi 1.5^{+0.10}_{-0.10}$	4.0	2.0	$0.30^{+0.10}_{-0.05}$
ALTERNATE													

11.2 /D

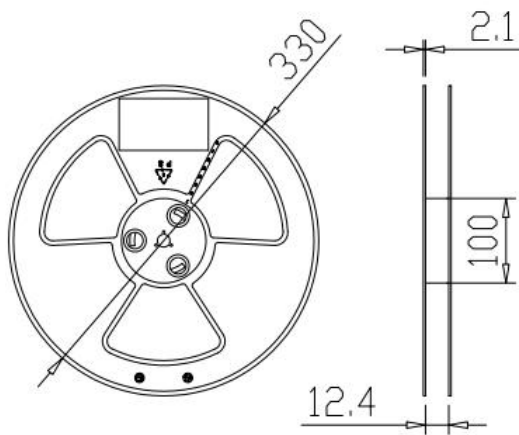

EEL	EEL I E
3000	13



11.3 /P

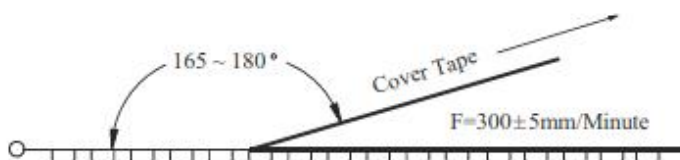

Item	Data	Remark
Cover tape adhesion	10 ~ 100g	Carrier tape and cover tape open angle 165 ~ 180° F=300±5mm/minute





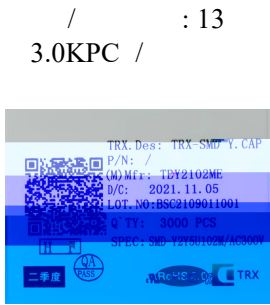
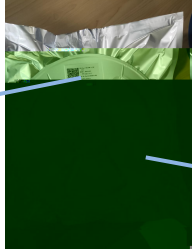
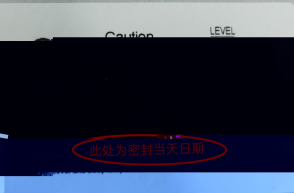

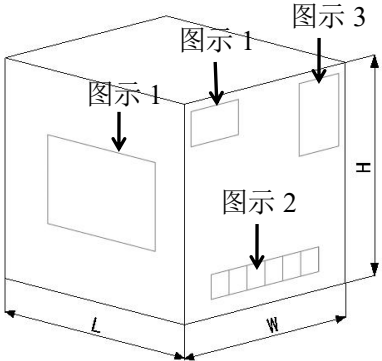
 <b>TRX</b> 专注电容器廿年	2 2 . .			
	/	-3-082	/	2021-11-15
	/	A1	/	P 17 18

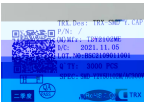
11.4 /P P

 <p>标签/L</p>	 <p>料号</p>	/I
 <p>3.0KPC /</p>		
/P	/L	/H
.D		
P/N		
M		
D/C		
L .N		
PEC		

				
图示 1/F 1	图示 2/F 2	图示 3/F 3		
D ( )		O B		
L	H	45KPC		10.0KG
355	358	294		

 <p>/O B</p>	 <p>15 / /15 /B</p>	 <p>( / / ) P (L/ /H) 1100*1100*90</p>	 <p>( / / ) (L/ /H) 1100*1100*1600</p>
---	--	--	---

1. 5 2. PALLE & APPING  
 3.50 :1. 5 ; 3.50 ; 4. N



	2 2 . .			
	/	-3-082	/	2021-11-15
	/	A1	/	P 18 18

12. /

①.

A

②.

PCB

PCB

PCB

C