

## IGBT Modules

**V<sub>CES</sub>** 1200V  
**I<sub>C</sub>** 10A

### Applications

Motor Drivers  
AC and DC servo drive amplifier  
UPS (Uninterruptible Power Supplies)

### Features

- Low switching losses
- Low v<sub>ce(sat)</sub> with positive temperature coefficient
- Including fast & soft recovery anti-parallel FWD
- Low inductance case
- High short circuit capability(10us)
- Isolated heatsink using DBC technology
- Maximum junction temperature 175

### Circuit

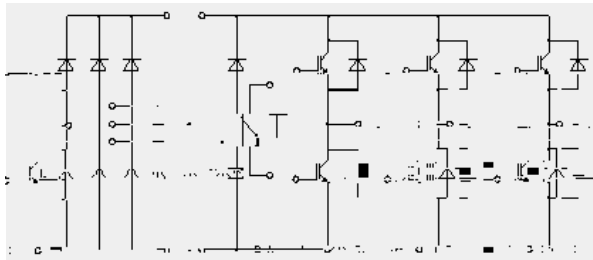

## IGBT- inverter

### Absolute Maximum Ratings

Parameter	Symbol	Conditions	Value	Unit
Collector-Emitter Voltage	V <sub>CES</sub>	V <sub>GE</sub> =0V, I <sub>C</sub> =1mA, T <sub>vj</sub> =25	1200	V
Continuous Collector Current	I <sub>C</sub>	T <sub>c</sub> =100 ,T <sub>vjmax</sub> =175	10	A
Repetitive Peak Collector Current	I <sub>CRM</sub>	tp=1ms	20	A
Gate-Emitter Voltage	V <sub>GES</sub>	T <sub>vj</sub> =25	±20	V
Total Power Dissipation	P <sub>tot</sub>	T <sub>c</sub> =25 T <sub>vjmax</sub> =175	140	W



## IGBT- inverter Characteristic values

Parameter	Symbol	Conditions	Value			Unit	
			Min.	Typ.	Max.		
Gate-emitter Threshold Voltage	$V_{GE(th)}$	$V_{GE}=V_{CE}, I_C=0.5mA, T_{vj}=25$	5.2	6.0	6.6	V	
Collector-Emitter Cut-off Current	$I_{CES}$	$V_{CE}=1200V, V_{GE}=0V, T_{vj}=25$			1.0	mA	
Collector-Emitter Saturation Voltage	$V_{CE(sat)}$	$I_C=10A, V_{GE}=15V, T_{vj}=25$		1.85	2.20	V	
		$I_C=10A, V_{GE}=15V, T_{vj}=125$		2.15			
		$I_C=10A, V_{GE}=15V, T_{vj}=150$		2.25			
Gate Charge	$Q_G$			0.13		uC	
Input Capacitance	$C_{ies}$	$V_{CE}=25V, V_{GE}=0V,$		1.0		nF	
Reverse Transfer Capacitance	$C_{res}$	$f=1MHz, T_{vj}=25$		0.03		nF	
Gate-Emitter leakage current	$I_{GES}$	$V_{CE}=0V, V_{GE}=20V, T_{vj}=25$			400	nA	
Turn-on Delay Time	$t_{d(on)}$	$I_C=10A$ $V_{CE}=600V$ $V_{GE}=\pm 15V$ $R_G=47$ $T_{vj}=25$		85		ns	
Rise Time	$t_r$			50		ns	
Turn-off Delay Time	$t_{d(off)}$				262		ns
Fall Time	$t_f$				140		ns
Energy Dissipation During Turn-on Time	$E_{on}$			0.98		mJ	



## Diode-inverter Absolute Maximum Ratings

Parameter	Symbol	Conditions	Value	Unit
Repetitive Peak Reverse Voltage	$V_{RRM}$	$T_{vj}=25$	1200	V
Continuous DC Forward Current	$I_F$		10	A
Repetitive Peak Forward Current	$I_{FRM}$	$t_p=1ms$	20	A
$I^2t$ -value	$I^2t$	$V_R=0, t_p=10ms, T_{vj}=125$	16.0	$A^2s$
		$V_R=0, t_p=10ms, T_{vj}=150$	14.0	

## Characteristic values

Parameter	Symbol	Conditions	Value			Unit
			Min.	Typ.	Max.	
Forward Voltage	$V_F$	$I_F=10A, T_{vj}=25$		2.0	2.5	V
		$I_F=10A, T_{vj}=125$		2.1		
		$I_F=10A, T_{vj}=150$		2.1		
Recovered Charge	$Q_{rr}$	$I_F =10 A$		0.90		$\mu C$
Peak Reverse Recovery Current	$I_{rr}$	$V_R=600V$ $-di_F/dt =500A/\mu s$		12.5		A
Reverse Recovery Energy	$E_{rec}$	$T_{vj}=25$		0.25		mJ
Recovered Charge	$Q_{rr}$	$I_F =10 A$		1.70		$\mu C$
Peak Reverse Recovery Current	$I_{rr}$	$V_R=600V$ $-di_F/dt =500A/\mu s$		10.4		A
Reverse Recovery Energy	$E_{rec}$	$T_{vj}=125$		0.50		mJ



## IGBT-brake-chopper Absolute Maximum Ratings

Parameter	Symbol	Conditions	Value	Unit
Collector-Emitter Voltage	$V_{CES}$	$V_{GE}=0V, I_C=1mA, T_{vj}=25$	1200	V
Continuous Collector Current	$I_C$	$T_c=100, T_{vjmax}=175$	10	A
Repetitive Peak Collector Current	$I_{CRM}$	$tp=1ms$	20	A
Gate-Emitter Voltage	$V_{GES}$	$T_{vj}=25$	$\pm 20$	V
Total Power Dissipation	$P_{tot}$	$T_c=25, T_{vjmax}=175$	105	W

## Characteristic Parameters



Turn-on Delay Time	$t_{d(on)}$	$I_C = 10A$ $V_{CE} = 600V$ $V_{GE} = \pm 15V$ $R_G = 47$ $T_{vj} = 125$		90		ns
Rise Time	$t_r$			60		ns
Turn-off Delay Time	$t_{d(off)}$			285		ns
Fall Time	$t_f$			150		ns
Energy Dissipation During Turn-on Time	$E_{on}$			1.33		mJ
Energy Dissipation During Turn-off Time	$E_{off}$			0.9		mJ
SC Data	$I_{sc}$	$T_p = 10\mu s, V_{GE} = 15V, T_{vj} = 150$ , $V_{cc} = 900V, V_{CEM} = 1200V$		70		A

## Diode-Brake-Chopper

### Absolute Maximum Ratings

Parameter	Symbol	Conditions	Value	Unit
Repetitive Peak Reverse Voltage	$V_{RRM}$	$T_j = 25$	1200	V
Continuous DC Forward Current	$I_F$		10	A
Repetitive Peak Forward Current	$I_{FRM}$	$t_p = 1ms$	20	A
$I^2t$ -value	$I^2t$	$V_R = 0, t_p = 10ms, T_j = 125$	16.0	A <sup>2</sup> s
		$V_R = 0, t_p = 10ms, T_j = 150$	14.0	

### Characteristic values

Parameter	Symbol	Conditions	Value			Unit
			Min.	Typ.	Max.	
Forward Voltage	$V_F$	$I_F = 10A, T_{vj} = 25$		2.0	2.5	V
		$I_F = 10A, T_{vj} = 125$		2.1		
		$I_F = 10A, T_{vj} = 150$		2.1		
Recovered Charge	$Q_{rr}$	$I_F = 10A$		0.90		uC
Peak Reverse Recovery Current	$I_{rr}$	$V_R = 600V$ $-di_F/dt = 500A/\mu s$		12.5		A
Reverse Recovery Energy	$E_{rec}$	$T_{vj} = 25$		0.25		mJ
Recovered Charge	$Q_{rr}$	$I_F = 10A$		1.70		uC
Peak Reverse Recovery Current	$I_{rr}$	$V_R = 600V$ $-di_F/dt = 500A/\mu s$		10.4		A
Reverse Recovery Energy	$E_{rec}$	$T_{vj} = 125$		0.50		mJ



## Diode-Rectifier Absolute Maximum Ratings

Parameter	Symbol	Conditions	Value	Unit
Repetitive Peak Reverse Voltage	$V_{RRM}$	$T_j=25$	1600	V
Average output Current 50/60Hz, sine wave	$I_{F(AV)}$	$T_c=100$	10	A
Maximum RMS Current at Rectifier Output	$I_{RMSM}$	$T_c=100$	10	A
Surge Forward Current	$I_{FSM}$	$V_R=0, t_p=10ms, T_j=45$	150	A
$I^2t$ -value	$I^2t$	$V_R=0, t_p=10ms, T_j=45$	110	A <sup>2</sup> s

## Characteristic values

Parameter	Symbol	Conditions	Value			Unit
			Min.	Typ.	Max.	
Diode Forward Voltage	$V_F$	$I_F=10A, T_j=150$		1.00		V
Reverse Current	$I_R$	$T_j=150, V_R=1600V$			1.0	mA

## NTC-Thermistor Characteristic values

Parameter	Symbol	Conditions	Value			Unit
			Min.	Typ.	Max.	
Rated Resistance	$R_{25}$			5.0		k
Deviation of R100	R/R	$T_c=100, R_{100}=493.3$	-5		5	%
Power Dissipation	$P_{25}$				20.0	mW
B-value	$B_{25/50}$	$R_2=R_{25}\exp[B_{25/50}(1/T_2-1/(298.15K))]$		3375		K

Parameter	Symbol	Conditions	Value			Unit
			Min.	Typ.	Max.	





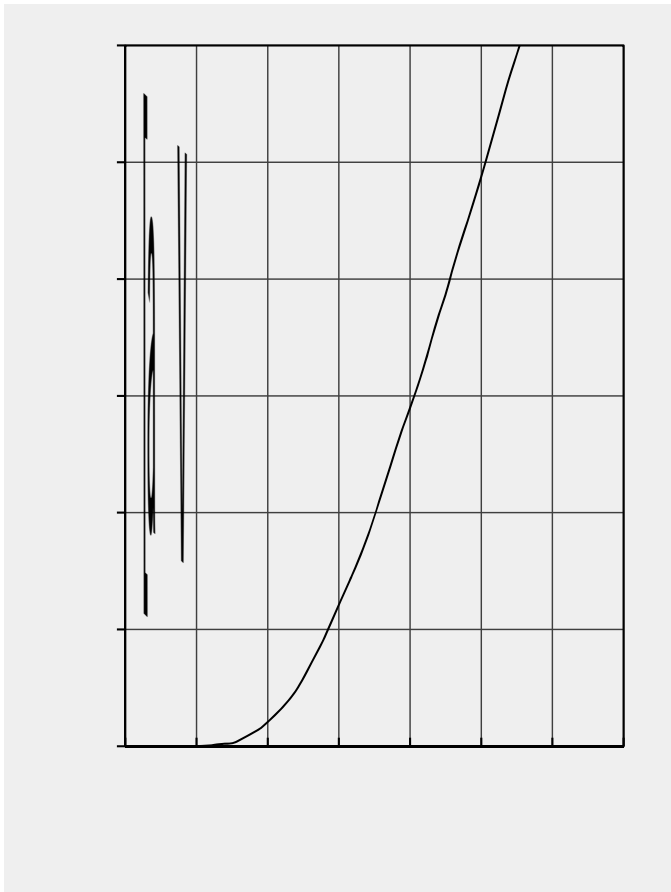
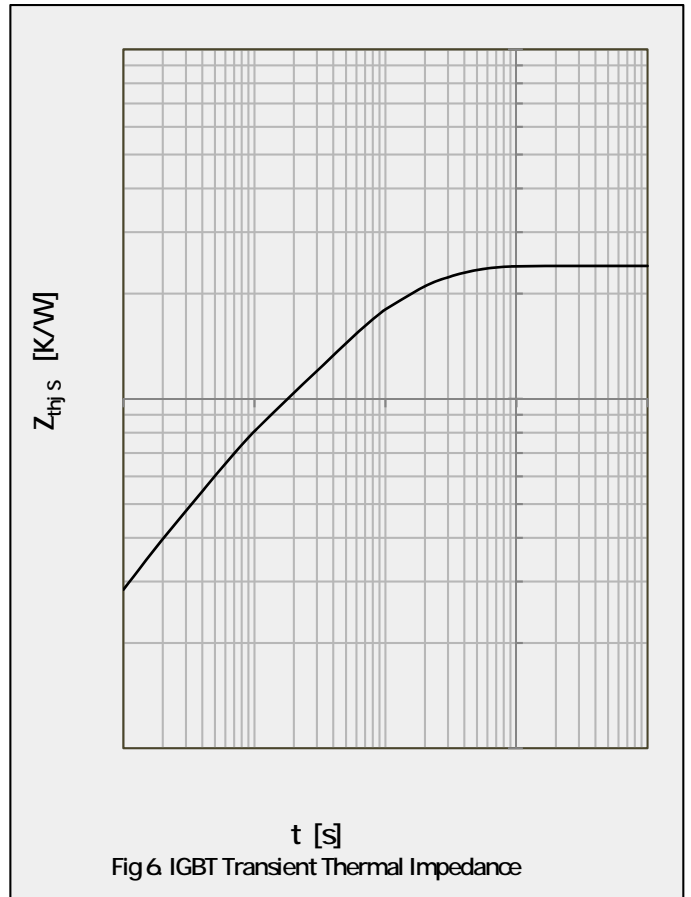
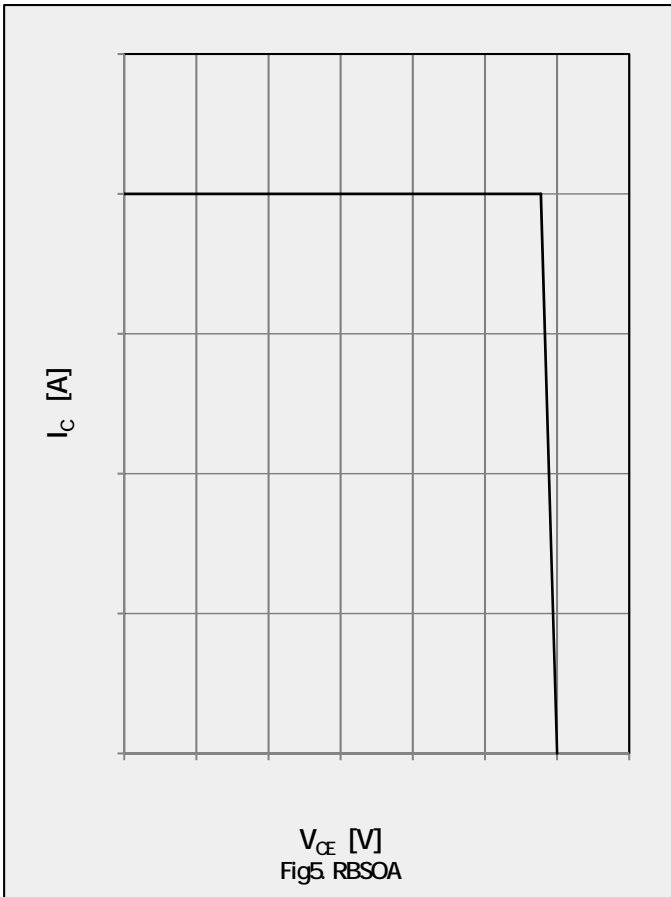

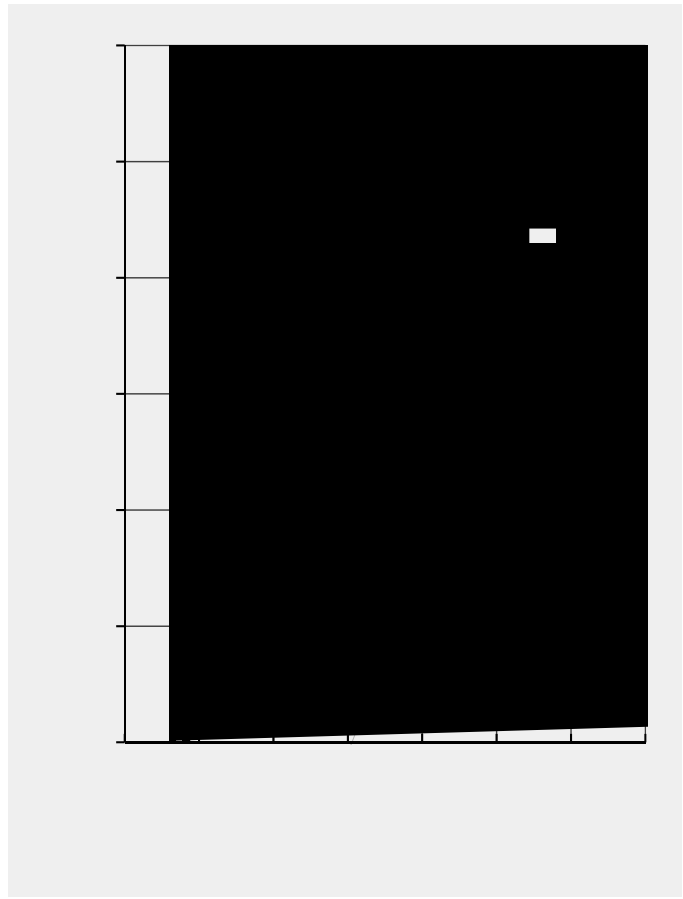
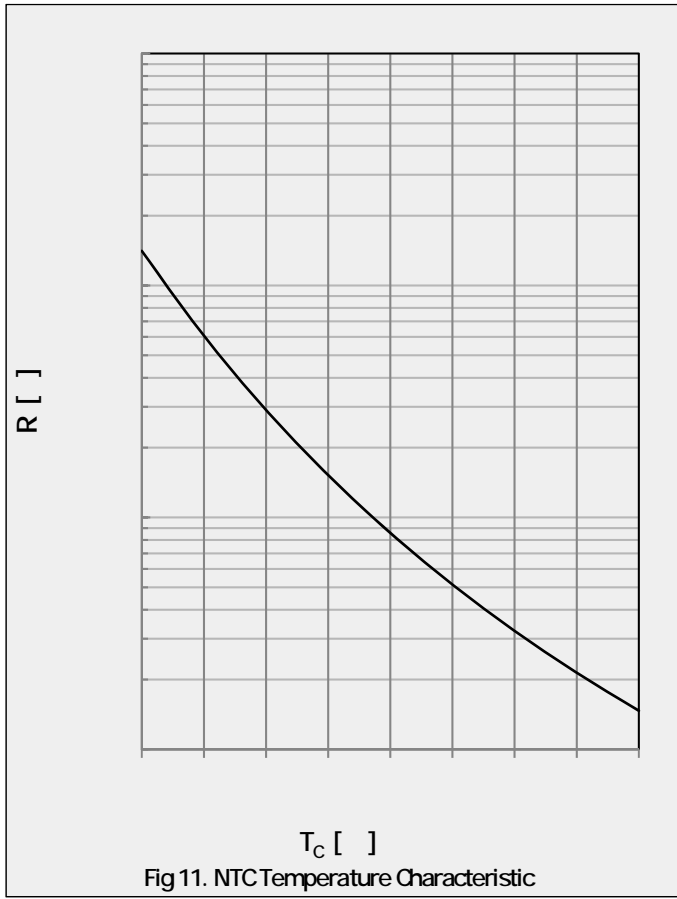
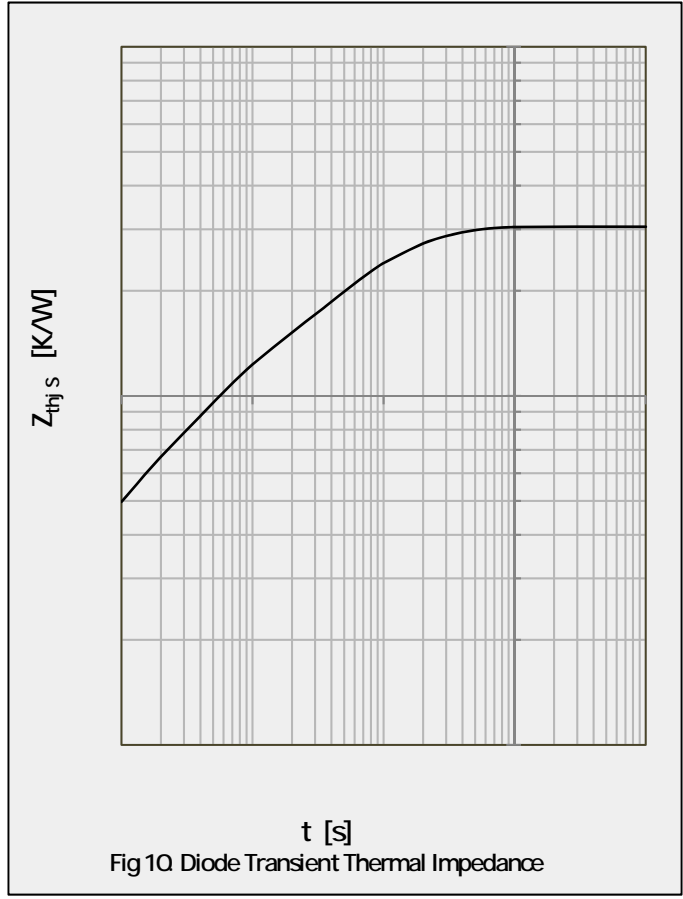
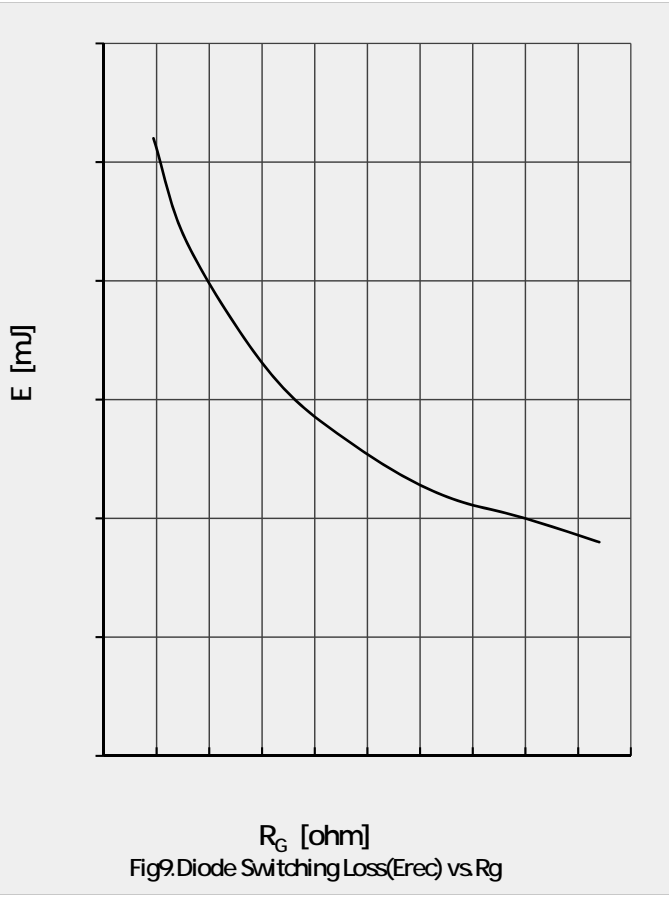

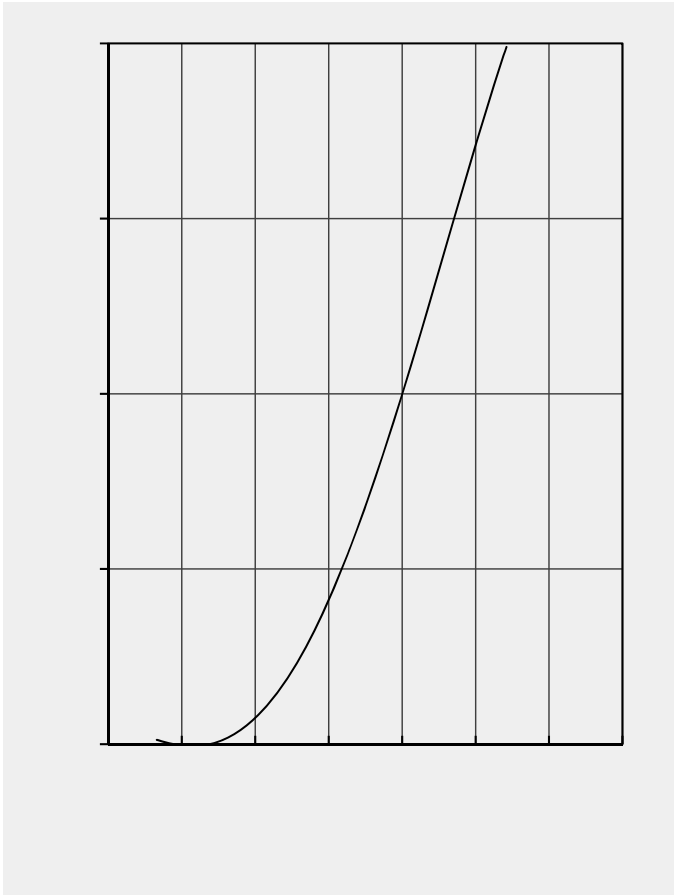



# MG10P12P2

RoHS  
COMPLIANT

## Circuit Diagram

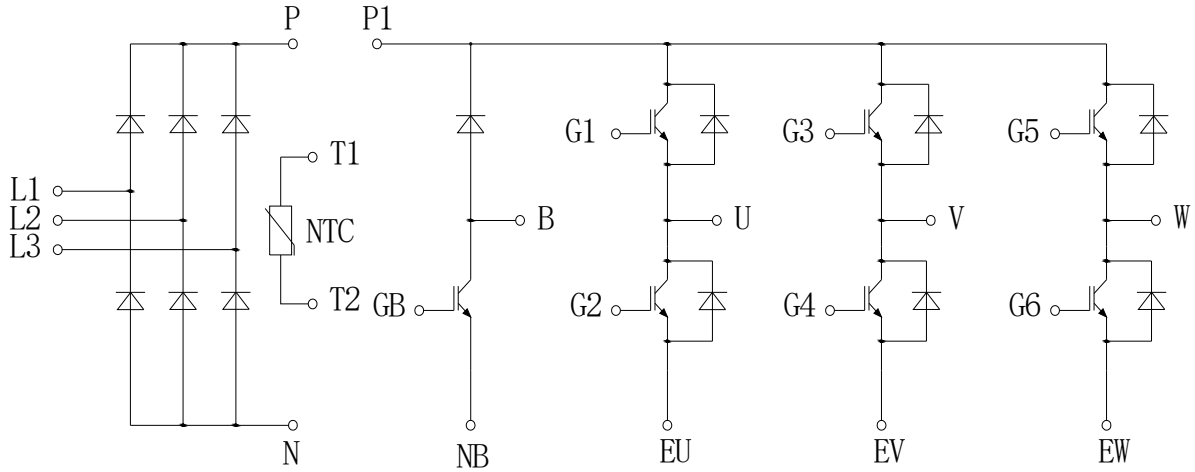

## Package Dimensions

