



深圳市弗瑞鑫电子有限公司

规格承认书

—
————
————

prepare	
check	
approve	



TRX 特锐祥
专 注 电 容 器 11 年

TRX电容一级代理商

深圳市弗瑞鑫电子有限公司

Add:深圳市宝安区西乡大道302号金源商务大厦B座3楼

Tel:0755-29563634

Fax:0755-27447020

- 2

2 . .

/

/

/

/

	- 2 2 . .		
	/		/
	/		/

	- 2 2 . .		
	/		/
	/		/

1. /

$\overline{\text{①}}$ $\overline{\text{②}}$ $\overline{\text{③}}$ $\overline{\text{④}}$ $\overline{\text{⑤}}$ $\overline{\text{⑥}}$

①

&

	- 2 2 . .		
	/		/
	/		/

3. /



4. /

5. /



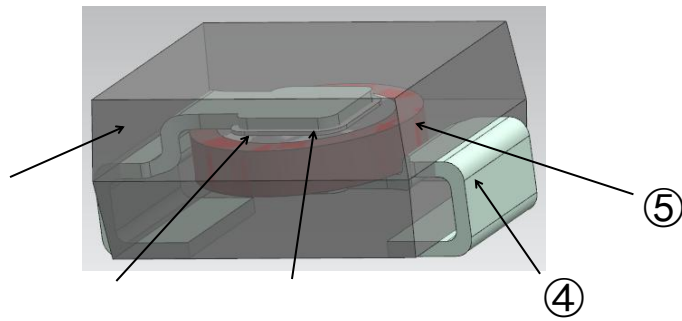

①		
②		
③		
④		
⑤		

- 2
2 ..

/

/

/

	- 2 2 . .		
	/		/
	/		/

/

°
°C

°

°

°

/

7. /

	- 2 2 . .		
	/		/
	/		/





- 2
2 ..

/

/

/

/

					±
		±			
		±			
		±			
		±			

			± ±
			± ±
			± ±
			± ±

8. /

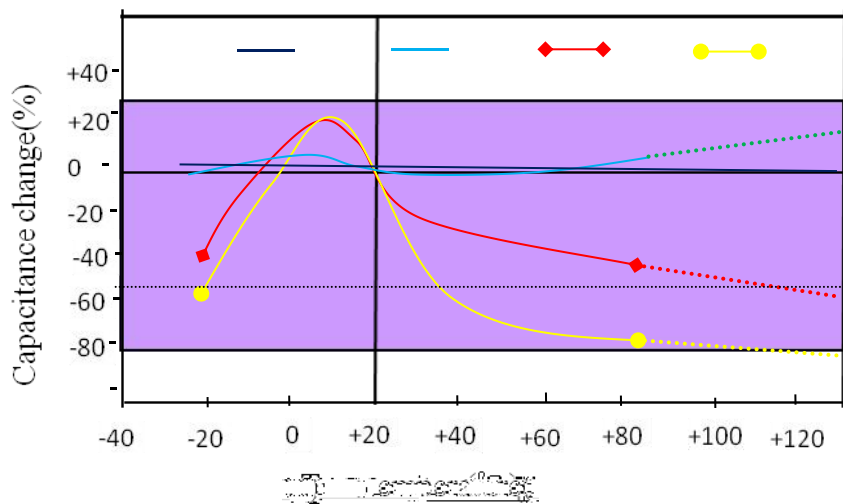

 TRX 专注电容器廿年	- 2 2 ..			
	/		/	
	/		/	

9. /



10. /

(1)

(2)

/
/

(3)

(4)

×

11. /
/

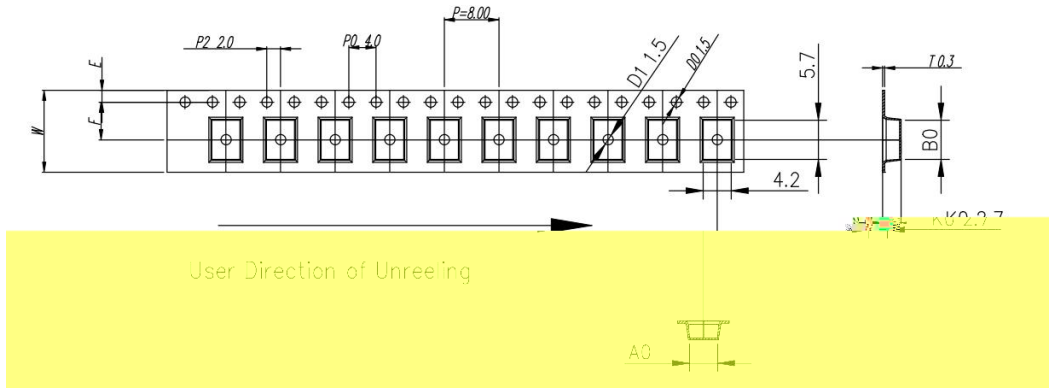



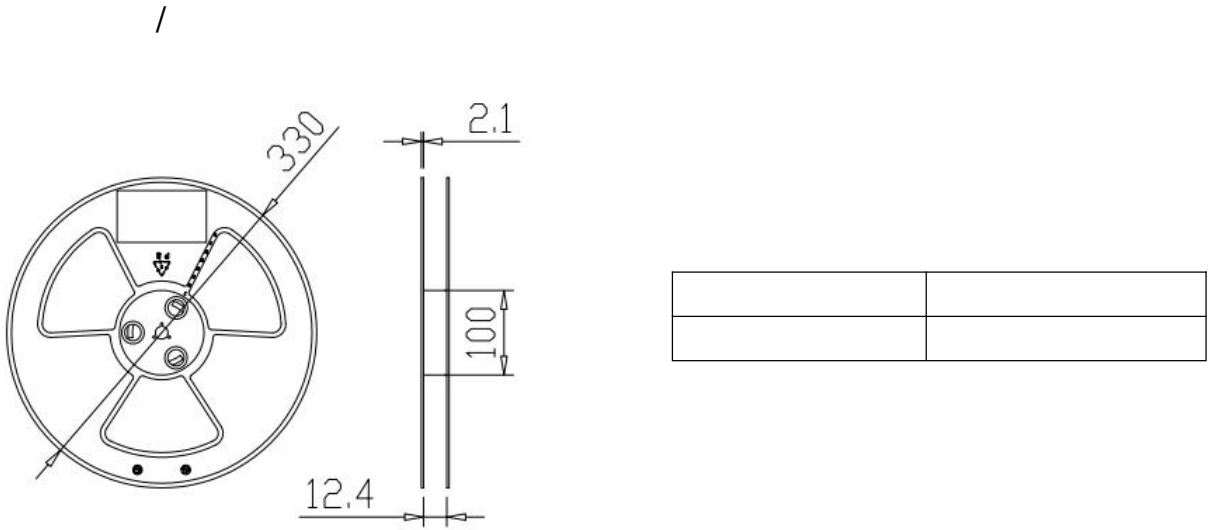

ITEM	W	A0	B0	K1	K0	P	F	E	D0	D1	P0	P2	T
DIM	12.0	4.7 ± 0.10	5.70 ± 0.10	--	2.70 ± 0.10	8.00 ± 0.10	5.50 ± 0.10	1.75 ± 0.10	$\phi 1.5 \pm 0.05$	$\phi 1.5 \pm 0.10$	4.0 ± 0.10	2.0 ± 0.10	0.30 ± 0.05
ALTERNATE													



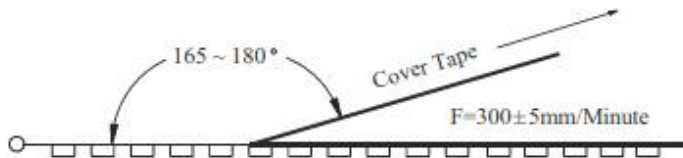

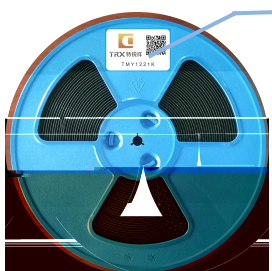

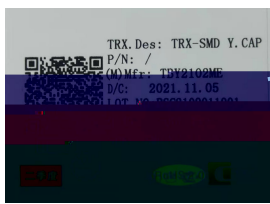
/

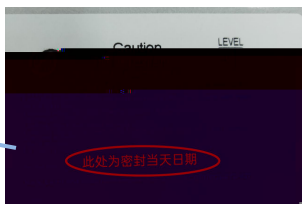
Item	Data	Remark
Cover tape adhesion	10 ~ 100g	Carrier tape and cover tape open angle 165 ~ 180° F=300±5mm/minute



/ -	 <p>标签</p>  <p>料号</p>    <p>此处为密封当天日期</p>								
-----	---------------------------------------------------------------------------------------------------------------------------------------------------------------------------------------------------------------------------------------------------------------------------------------------------------------------------------------------------------------------------------------------------------------------------------------------------------------------	--	--	--	--	--	--	--	--

/ -					图示 / 图示 / 图示 /									

/ :					/ / / /								
-----	-------------------------------------------------------------------------------------	-------------------------------------------------------------------------------------	--------------------------------------------------------------------------------------	---------------------------------------------------------------------------------------	------------------------------------------------------------------------	--	--	--	--	--	--	--	--

" "

	- 2 2 . .		
	/		/
	/		/

12. /

①

②