

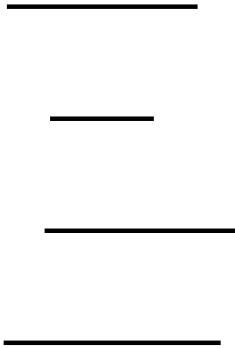

1 1





**TRX 特锐祥**  
专注电容器材料



	<b>SMD-Y1</b> <b>SMD Y1 a.c. ceramic capacitors</b>		
	/Number		/Date
	/Edition		/Page

**/ attached sheet I**

**/ attached sheet II**

**TRX SMD-Y1.CAP**  
**Capacitance Range and T.C Differentiation (Unit:pF**

<b>T.C</b>						

	<b>SMD-Y1</b>		
	<b>SMD Y1 a.c. ceramic capacitors</b>		
	/Number		/Date
	/Edition		/Page

 <b>TRX</b> 专注电容器廿年	<b>SMD-Y1</b> <b>SMD Y1 a.c. ceramic capacitors</b>		
	/Number		/Date
	/Edition		/Page

1. /Product Name

**T G Y1 102 K**

		×

2. / Product marking

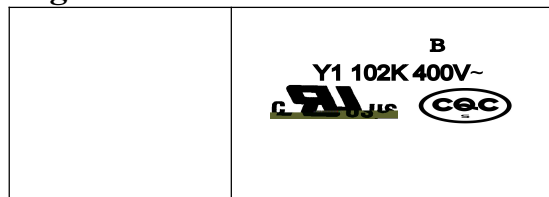





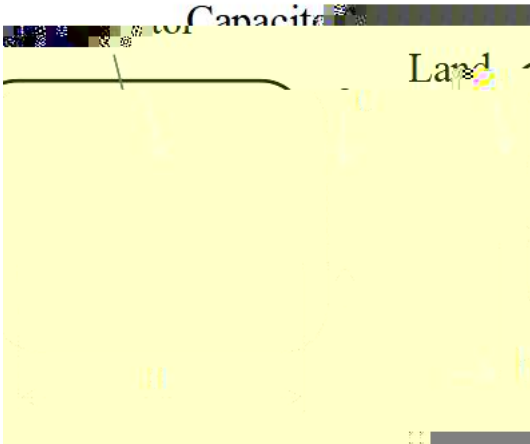

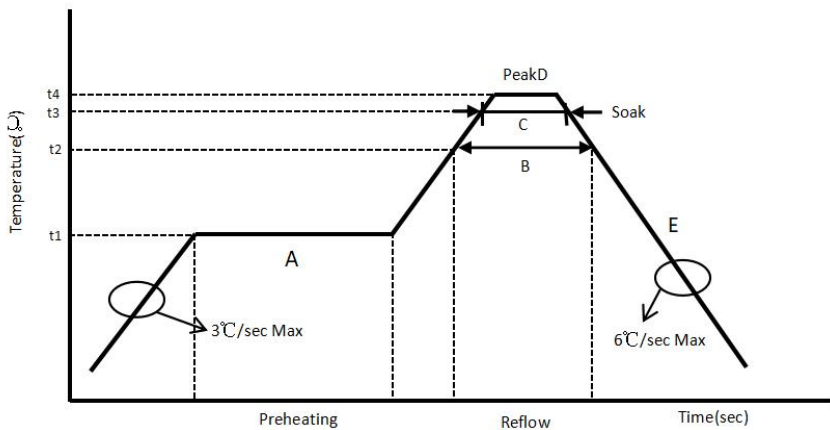

**6. / Soldering condition**

/





	<b>SMD-Y1</b>		
	<b>SMD Y1 a.c. ceramic capacitors</b>		
	/Number		/Date
/Edition		/Page	

/

/

**7. / Performance and test methods**



**SMD-Y1**  
**SMD Y1 a.c. ceramic capacitors**

/Number

/Date

/Edition

/Page



±



**SMD-Y1**  
**SMD Y1 a.c. ceramic capacitors**

/Number

/Date

/Edition

/Page

±





			± ±
			± ± ±
			± ± ±

**8. /Capacitor temperature characteristic**

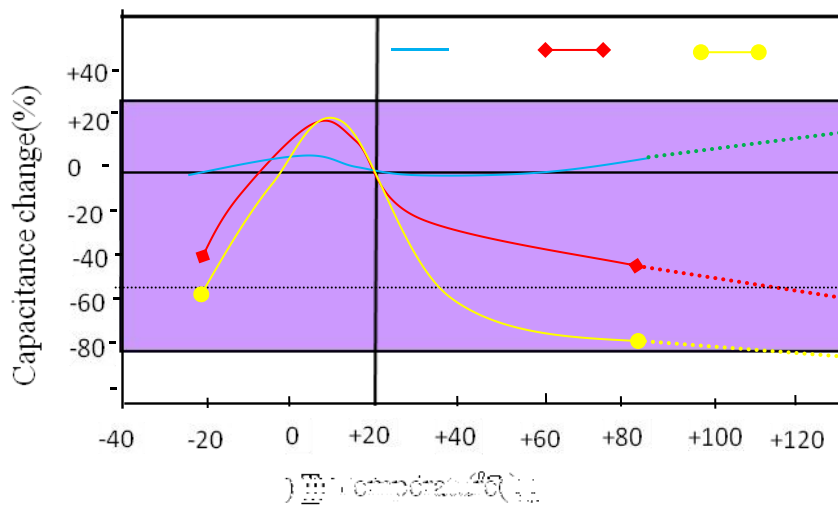

 <b>TRX</b> 专注电容器廿年	<b>SMD-Y1</b> <b>SMD Y1 a.c. ceramic capacitors</b>		
	/Number		/Date
	/Edition		/Page

9. /Content of toxic and harmful substances control requirements

**RoHS H.F.  
REACH**



10. /Storage conditions

/

/

### 11. /Product packaging

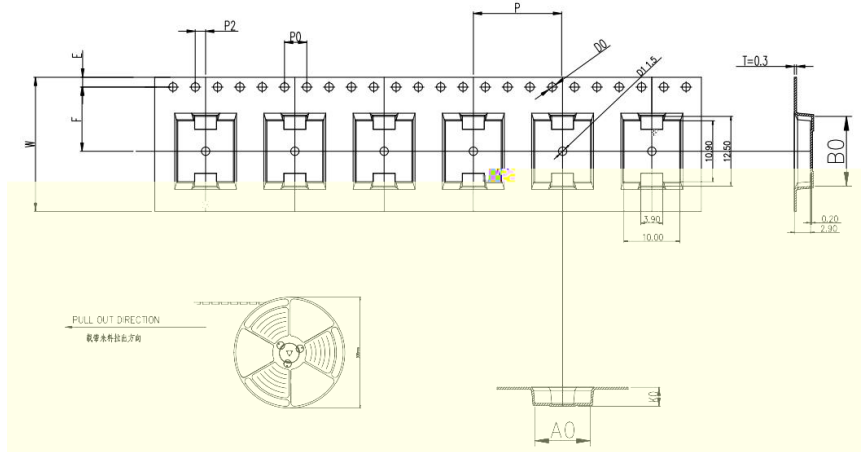
/



ITEM	W	A0	B0	K1	K0	P	F	E	D0	D1	P0	P2	T
DIM	24.0	$^{+0.30}_{-0.30}$	$^{+0.10}_{-0.10}$	$^{+0.10}_{-0.10}$	$^{+0.10}_{-0.10}$	$^{+0.10}_{-0.10}$	$^{+0.10}_{-0.10}$	$^{+0.10}_{-0.10}$	$^{+0.10}_{-0.00}$	$^{+0.10}_{-0.00}$	$^{+0.10}_{-0.10}$	$^{+0.10}_{-0.10}$	$^{+0.05}_{-0.05}$
ALTERNATE													

/

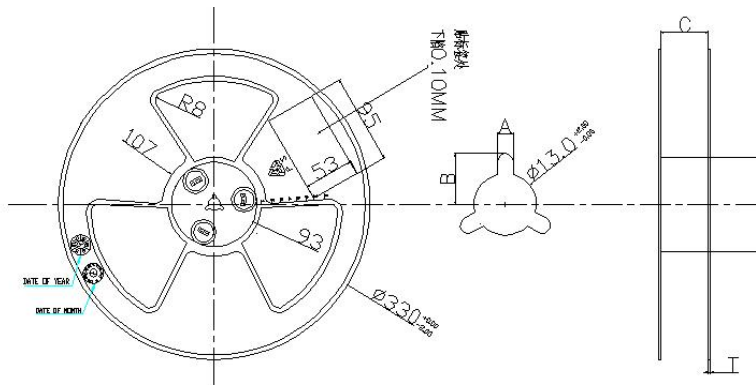

SPEC	A±0.3	B±0.5	C $^{+0.5}_{-0.0}$	D±0.5	T±0.2
24	2.3	10.75	24.4	Ø97	2.2

/

Item	Data	Remark
Cover tape adhesion	10 ~ 100g	Carrier tape and cover tape open angle 165 ~ 180° F=300± 5mm/minute

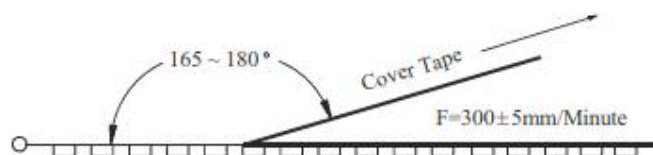



 <b>TRX</b> 专注电容器廿年	<b>SMD-Y1</b> <b>SMD Y1 a.c. ceramic capacitors</b>		
	/Number		/Date
	/Edition		/Page

**/inner-packaging**

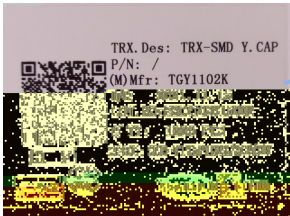
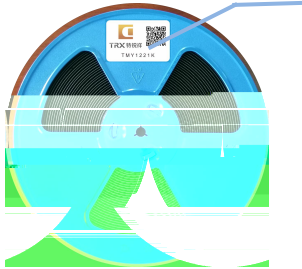

**/Outer-packaging**

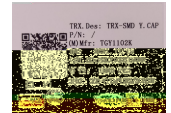
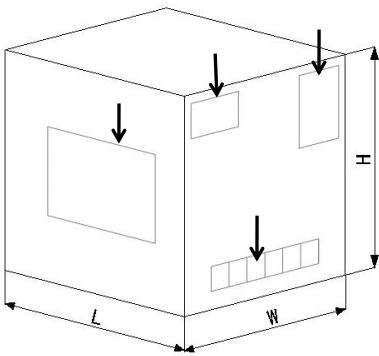

/	/	/

**/Package sketch:**



/

/

" "

**Remark**

